

get started

INSTANT™ **20-CUP**
MULTIGRAIN RICE COOKER
+ STEAMER
USER MANUAL

Instant™

Welcome

to your new Instant™ Multigrain Rice Cooker + Steamer!

This Instant Multigrain Rice Cooker + Steamer can help you cook delicious meals more easily and in less time. We hope you fall in love with Instant cooking, and enjoy it in your kitchen for years to come!

Get started with your Rice Cooker + Steamer!

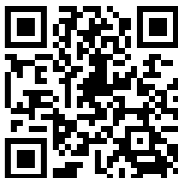

Scan to Get Started!

To make your cooking experience with Instant as easy as possible, we have created 4 simple steps with how-to videos to guide you. Scan the QR code and follow the steps to become an Instant Chef in no time!

www.instantpot.co.uk/get-started



Download the **Instant Connect app** to access 100's of recipe ideas.



Visit the **Instant Pot Brands UK YouTube channel** for how-to videos and recipe inspiration.



Connect with the **Instant Pot UK Facebook Community**, and be inspired with cooking tips, tricks and recipes from this active group of Instant chefs!

⚠️WARNING

Before using your new Rice Cooker, read all instructions, including the Safety and Warranty document. Failure to follow the safeguards and instructions may result in personal injury and/or property damage.

CONTENTS

Important safeguards	2
What's in the box	5
Using your Rice Cooker + Steamer	7
Initial setup	9
Using the lid	10
White or brown rice	11
CarbReduce™	13
Mixed Grain	15
Quinoa	16
Steam	17
Slow cook	19
Sauté	21
Keep warm	23
Grain cooking table	24
Steaming timetable	25
Troubleshooting	26
Learn more	28
Warranty	29
CarbReduce™ study	31

IMPORTANT SAFEGUARDS

⚠️ WARNING

READ ALL INSTRUCTIONS

Placement

- **DO** place the appliance on a countertop only. Always operate the appliance on a stable, non-combustible, level surface.
- **DO** make sure all parts are dry and free of food debris before placing the Cooking Pot on the cooker base.
- **DO NOT** place the appliance on or close to a hot gas or electric burner, or a heated oven.
- **DO NOT** use the appliance near water or flame.
- **DO NOT** use outdoors. Keep out of direct sunlight.
- **DO NOT** place on anything that may block the vents on the sides of the appliance.

General Use

The removable Cooking Pot is extremely hot during use, and can be extremely heavy when full of ingredients.

- **DO** use oven mitts when handling the Cooking Pot and CarbReduce Basket, and when removing accessories.
- **DO** place hot accessories on a heat-resistant surface or cooking plate.
- **DO** use care when lifting the Cooking Pot or CarbReduce Basket from the cooker base to avoid burn injury.
- **DO** use extreme caution when the Cooking Pot and CarbReduce Basket contain hot food, hot oil or other hot liquids.
- **DO NOT** use the appliance without the removable Cooking Pot installed.
- **DO NOT** touch the metal portion of the lid, the appliance's hot surfaces, or any accessories during or immediately after cooking because they will be hot. Only use the side handles for carrying or moving.
- **DO NOT** use this appliance for deep frying with oil.
- **DO NOT** move the appliance while it is in use and use extreme caution when disposing of hot grease.

⚠ WARNING

- **DO NOT** allow children or persons with reduced physical, sensory or mental capabilities to operate this appliance. Close supervision is necessary when any appliance is used by or near children and persons with reduced physical, sensory or mental capabilities. Children should not play with this appliance.
- **DO NOT** use the appliance for anything other than household use. It is not intended for commercial use.
- **DO NOT** leave the appliance unattended while in use.

Accessories

- **DO** use only accessories or attachments authorised by Instant Brands. The use of parts, accessories or attachments not recommended by the manufacturer may cause a risk of personal injury, property damage, fire or electric shock.
- **DO** only replace the Inner Lid Cover with an authorised Instant™ Inner Lid Cover to prevent personal injury, property damage, and/or damage to the appliance.
- **DO NOT** use the included accessories in a microwave, toaster oven, convection or conventional oven, or on a ceramic cooktop, electric coil, gas range or outdoor grill.

Care and Storage

- **DO** let the appliance cool to room temperature before cleaning or storage.
- **DO NOT** store any materials in the cooker base when not in use.
- **DO NOT** place any combustible materials in the cooker base, such as paper, cardboard, plastic, Styrofoam or wood.

Power Cord

A short power-supply cord is used to reduce the risk resulting from it being grabbed by children, becoming entangled in, or tripping over a longer cord.

WARNING: Spilled food can cause serious burns. Keep appliance and cord away from children.

Never drape cord over edge of counter, never use outlet below counter, and never use with an extension cord.

- **DO NOT** let the power cord touch hot surfaces or open flame, including the stovetop.
- **DO NOT** use with power converters or adapters, timer switches or separate remote-control systems.

⚠ WARNING

If the unit includes a detachable power cord:

- To connect, always attach the power cord to the appliance first, then plug the power cord into the wall outlet.

Electrical Warning

The cooker base contains electrical components that are an electrical shock hazard. Failure to follow these instructions may result in electric shock.

To protect against electrical shock:

- To disconnect, select **Cancel**, then remove plug from power source. Always unplug when not in use, as well as before adding or removing parts or accessories, and before cleaning. To unplug, grasp the plug and pull from the outlet. Never pull from the power cord.
- **DO** regularly inspect the appliance and power cord. **DO NOT** operate the appliance if the power cord or plug is damaged, or after the appliance malfunctions or is dropped or damaged in any manner. For assistance, contact Customer Care by email at **UKSupport@instantbrands.com** (if located in the UK) or **EUSupport@instantbrands.com** (if located in the EU).
- **DO NOT** attempt to repair, replace or modify components of the appliance, as this may cause electric shock, fire, property damage, or personal injury, and will void the warranty.
- **DO NOT** tamper with any of the safety mechanisms, as this may result in personal injury or property damage.
- **DO NOT** put liquid or food of any kind into cooker base without the Cooking Pot.
- **DO NOT** immerse power cord, plug or the appliance in water or other liquid.
- **DO NOT** use the appliance in electrical systems other than 220-240 V ~ 50-60 Hz.
- **DO NOT** clean the appliance by rinsing it under a faucet.

**SAVE THESE
INSTRUCTIONS**

WHAT'S IN THE BOX

Lid

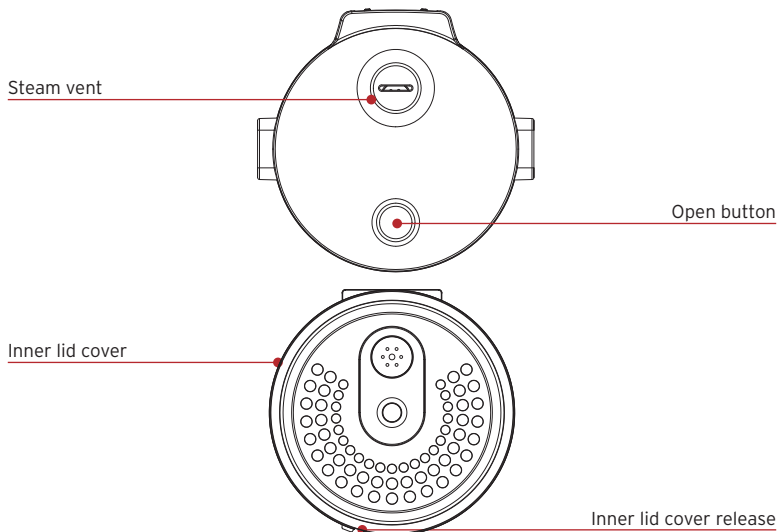

Cooker Base

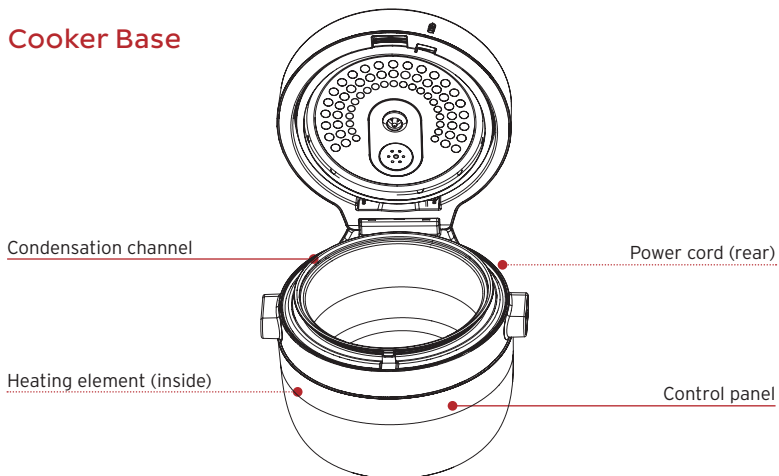

Parts + Accessories

Inner lid cover

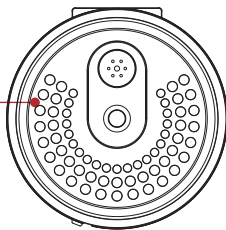

Ceramic coated non-stick
Cooking Pot

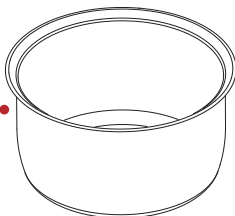

Stainless steel steam basket

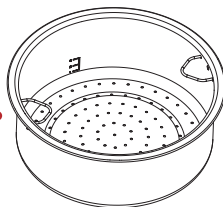

Measuring cup



Rice spoon



Illustrations are for reference only and may differ from the actual product.

Remember to recycle!

We designed this packaging with sustainability in mind. Please recycle everything that can be recycled where you live.

USING YOUR RICE COOKER + STEAMER

Control panel

We've designed the control panel to be simple to use and easy to read.

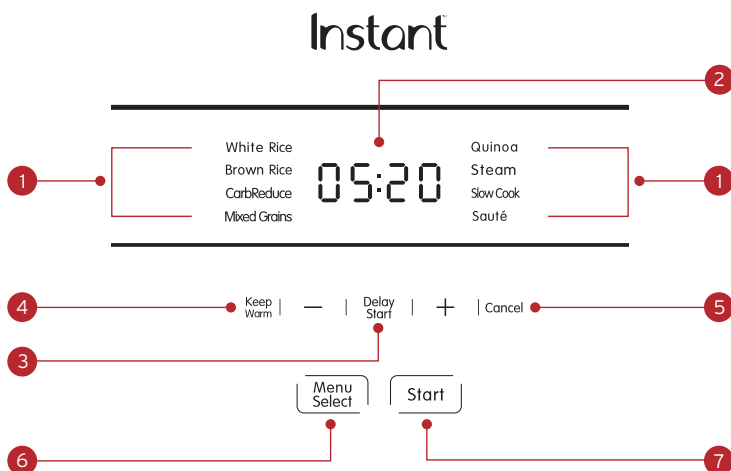

1. Smart Programme Settings
2. Time
 - Cooking time
 - Delay Start time
 - Keep Warm time
3. Delay Start
 - Shows Delay Start is active
4. Keep Warm
 - Shows Keep Warm is active
5. Cancel
6. Menu Select
7. Start

Delay the start of cooking

You can set a Delay Start timer for a minimum of 10 minutes or a maximum of 24 hours.

1. Select a Smart Programme, then press **Delay Start**.
2. When the timer flashes, press **+** or **-** to set the minutes (in 10 minute increments) and press **Start** to select.
3. Delay Start begins automatically and the timer counts down.
4. When Delay Start ends, the Smart Programme begins.

Cancel cooking

Press **Cancel** to stop cooking at any time.

INITIAL SETUP

Unpack

1. Remove your new Rice Cooker + Steamer from the box.
2. Remove all the packaging material from in and around the cooker.
3. Make sure to remove all the accessories from inside the cooking chamber.
4. **DO NOT** remove the safety warning stickers or the rating label from the cooker.

Clean before use

1. Wipe the interior with a damp cloth. Use a clean, soft cloth to dry.
2. Wash the accessories with hot water and dish soap or wash on the top rack of the dishwasher. Rinse with warm, clear water and use a soft cloth to dry.

Placement

1. Place your Cooker on a stable, level surface, away from combustible material and external heat sources. **DO NOT** place the unit on top of another appliance.
2. Make sure to leave at least 13 cm of space above and around all sides of the appliance to allow for sufficient air flow.

Turn on

1. Plug the unit into an electric outlet. The Control Panel will light up.

USING THE LID

How to close the lid

Push the lid down lightly until you feel it click into place. If you push too hard or too fast the lid will bounce back open.

How to open the lid

When cooking is finished, push the button on top of the lid to open.

DO NOT open the lid during cooking as hot steam can burn.

About the Inner Lid Cover

The Inner Lid Cover is removable for easy cleaning. When cooking, the Cover must be in place on the lid.

- To remove the cover, press the Release Button and the cover will pop off.
- To replace the cover, place the flat edge of the cover into the slot and press the cover onto the Inner Lid until it clicks into place.

About the condensation channel

During cooking, steam will condense, and the condensation will collect in the channel of the base. After cooking, open the lid slowly to avoid spillage. When you open the lid, condensation will flow into the collection space. You can let it evaporate or clean it up with a paper towel.

⚠ WARNING

HOT SURFACES To prevent electric shock or personal injury, unplug before cleaning.

DO NOT immerse power cord, plug or the appliance in water or other liquid, which may result in electric shock or personal injury.

WHITE OR BROWN RICE

The White Rice and Brown Rice programmes cook rice quickly and evenly, and automatically adjust cooking times for the amount of rice in the Cooking Pot.

Choose from these Smart Programmes:

Programme	Cook Time	Min Dry Rice	Max Dry Rice	Rice to Water Ratio
White Rice	5 minutes (00:05)	1 cup*	4 cups*	1 cup rice to 1.5 cups water
Brown Rice	10 minutes (00:10)	1 cup*	3 cups*	1 cup rice to 1.2 cups water

* Please measure in the Rice Cup included with the Cooker and not a standard measuring cup

Other settings

- Automatic Keep Warm is set to ON by default for both Rice programmes.
- Delay Start is available for both Rice programmes.

How to cook rice

1. Add dry rice and water to the Cooking Pot and place the Cooking Pot into the cooker base.
2. Close the lid.
3. Press **Menu Select** on the Control Panel; press again until **White Rice** or **Brown Rice** is highlighted.
4. You can delay cooking if you want. Press **Delay Start**, then press **+** or **-** to select the delay time.
5. Keep Warm setting is ON by default.
6. Press **Start**.

The cooking timer for white rice will start counting down during the last 5 minutes of the cooking cycle, the cooking timer for brown rice will start counting down during the last 10 minutes of the cooking cycle.

You can press **Cancel** to stop cooking at any time.

Stop cooking

1. When cooking time reaches 00:00, cooking stops.
2. Keep Warm comes on and the display reads **END**.
3. Press **Cancel** to end Keep Warm when you're ready to serve.

CarbReduce™

The CarbReduce programme cooks rice and uses special technology to reduce the amount of carbohydrates and sugar.

Programme	Cook Time	Min Dry Rice	Max Dry Rice	Grains to Water Ratio
CarbReduce	40 minutes (00:40)	1 cup*	3 cups*	Use the measure marks in the basket for the amount of grains you want to cook

** Please measure in the Rice Cup included with the Cooker and not a standard measuring cup*

Carbohydrate reduction is optimized when cooking batches of 2 [dry] cups or less. To maximize this benefit, we recommend doing 1-2 cup (dry) volumes, which equates to 4-8 servings.

Other settings

- Automatic Keep Warm is set to ON by default for CarbReduce programme.
- Delay Start is available for CarbReduce programme.

How to cook using CarbReduce

1. Add dry rice to the CarbReduce Steam Basket and place the basket into the Cooking Pot.
2. Fill the basket with water according to the measure marks for the amount of rice you want to cook.
3. Close the lid.
4. Press **Menu Select** on the Control Panel; press again until **CarbReduce** is highlighted.
5. You can delay cooking if you want. Press **Delay Start**, then press **+** or **-** to select the delay time.
6. Keep Warm setting is ON by default.
7. Press **Start**. The cooking time starts counting down.

You can press **Cancel** to stop cooking at any time.

Stop cooking

1. When cooking time reaches 00:00, cooking stops.
2. Keep Warm comes on and the display reads **END**.
3. Press **Cancel** to end Keep Warm when you're ready to serve.

CarbReduce results based on 2 cups (uncooked) of long grain white rice, long grain brown rice, short grain white rice, arborio rice, and basmati white rice varieties, using recommended cooking process and water ratio.

Results may vary depending on batch quantity and rice variety used.

CarbReduce not recommended for long grain white rice variety batches greater than 2 cups due to diminished carbohydrate reduction.

MIXED GRAINS

The Mixed Grains program cooks a variety of grains quickly and evenly.

Program	Cook Time	Min Dry Grains	Max Dry Grains	Grains to Water Ratio
Mixed Grains	10 minutes (00:10)	1 cup*	6 cups*	1 cup grains to 1.2 cups water

* Please measure in the Rice Cup included with the Cooker and not a standard measuring cup

Other settings

- Automatic Keep Warm is set to ON by default.
- Delay Start is available.

How to cook mixed grains

1. Add dry grains and water to the Cooking Pot and place the Cooking Pot into the cooker base.
2. Close the lid on top of the cooker base.
3. Press **Menu Select** on the Control Panel; press again until **Mixed Grains** is highlighted.
4. You can delay cooking if you want. Press **Delay Start**, then press **+** or **-** to select the delay time.
5. Keep Warm setting is ON by default.
6. Press **Start**.

The cooking timer will start counting down during the last 10 minutes of the cooking cycle.

You can press Cancel to stop cooking at any time.

Stop cooking

1. When cooking time reaches 00:00, cooking stops.
2. Keep Warm comes on and the display reads **END**.
3. Press **Cancel** to end Keep Warm when you're ready to serve.

QUINOA

The Quinoa program cooks quinoa quickly and evenly.

Program	Cook Time	Min Dry Quinoa	Max Dry Quinoa	Quinoa to Water Ratio
Quinoa	5 minutes (00:05)	1 cup*	6 cups*	1 cup quinoa to 1.5 cups water

* Please measure in the Rice Cup included with the Cooker and not a standard measuring cup

Other settings

- Automatic Keep Warm is set to ON by default.
- Delay Start is available.

How to cook quinoa

1. Add dry quinoa and water to the Cooking Pot and place the Cooking Pot into the cooker base.
2. Close the lid on top of the cooker base.
3. Press **Menu Select** on the Control Panel; press again until **Quinoa** is highlighted.
4. You can delay cooking if you want. Press **Delay Start**, then press **+** or **-** to select the delay time.
5. Keep Warm setting is ON by default.
6. Press **Start**.

The cooking timer will start counting down during the last 5 minutes of the cooking cycle.

You can press Cancel to stop cooking at any time.

Stop cooking

1. When cooking time reaches 00:00, cooking stops.
2. Keep Warm comes on and the display reads **END**.
3. Press **Cancel** to end Keep Warm when you're ready to serve.

STEAM

The Steam programme cooks food using steam; it's especially useful for vegetables like broccoli, courgette, carrots, and more.

Programme	Default Cook Time	Min Cook Time	Max Cook Time
Steam	10 minutes (00:10)	5 minutes (00:05)	1 hour (01:00)

Other settings

- Automatic Keep Warm is set to ON by default for Steam Programme.
- Delay Start is available for Steam Programme.

How to steam

Prep

Cut, chop or season your ingredients according to your recipe.

Cook

1. Add water (minimum 1/2 cup, maximum to just below the CarbReduce Steam Basket) to the Cooking Pot and place it into the cooker base.
2. Add food to the CarbReduce Steam Basket and place the steam basket into the Cooking Pot, then place that into the cooker base.
3. Close the lid.
4. Press **Menu Select** on the Control Panel; press again until **Steam** is highlighted. Then press **Start** to select it.
5. The default cooking time flashes. To select it, press **Start**. Or press **+** or **-** to change it, then press **Start** to select it. The cooking time starts counting down.
6. You can delay cooking if you want. Press **Delay Start**, then press **+** or **-** to select the delay time.
7. Keep Warm setting is ON by default.

*You can press **Cancel** to stop cooking at any time.*

Stop cooking

1. When cooking time reaches 00:00, cooking stops.
2. Keep Warm comes on and the display reads **END**.
3. Press **Cancel** to end Keep Warm when you're ready to serve.

SLOW COOK

Slow cooking lets you make your favourite simmering and stewing recipes – just like grandma used to make.

Programme	Default Cook Time	Min Cook Time	Max Cook Time
Slow Cook	6 hours (06:00)	30 minutes (00:30)	24 hours (24:00)

Other settings

- Automatic Keep Warm is set to ON by default for Slow Cook programme.
- Delay Start is available for Slow Cook programme.

How to slow cook

Prep

Cut, chop, season or marinate your ingredients according to your recipe.

Cook

1. Add ingredients to the Cooking Pot and place the Cooking Pot into the cooker base.
2. Close the lid.
3. Press **Menu Select** on the Control Panel; press again until **Slow Cook** is highlighted. Then press **Start** to select it.
4. If you want to delay cooking, press **Delay Start** before pressing **Start**, then press **+** or **-** to select the delay time.
5. The default cooking time flashes. To select it, press **Start**. Or press **+** or **-** to change it, then press **Start** to select it. The cooking time starts counting down.
6. Keep Warm setting is ON by default.

*You can press **Cancel** to stop cooking at any time.*

Stop cooking

1. When cooking time reaches 00:00, cooking stops.
2. Keep Warm comes on and the display reads **END**.
3. Press **Cancel** to end Keep Warm when you're ready to serve.

SAUTÉ

Use Sauté in place of a frying or saucepan. Sautéing can deepen the flavours of your food, or can simmer, thicken or reduce sauces.

Programme	Default Cook Time	Min Cook Time	Max Cook Time
Sauté	30 minutes (00:30)	1 minute (00:01)	30 minutes (00:30)

Other settings

- Automatic Keep Warm is OFF by default.
- Delay Start is not available.

How to sauté

Prep

Cut, chop, season or marinate your ingredients according to your recipe.

Cook

1. Place the Cooking Pot into the cooker base.
2. Add oil to the Cooking Pot and press **Start**.
3. Press **Menu Select** on the Control Panel; press again until **Sauté** is highlighted. Then press **Start** to select it.
4. The default cooking time flashes. To select it, press **Start**. Or press **+** or **-** to change it, then press **Start** to select it. The cooking time starts counting down.

*You can press **Cancel** to stop cooking at any time.*

Stop cooking

1. When cooking time reaches 00:00, cooking stops.
2. Keep Warm setting is OFF by default. To use it, press **Cancel** when the Sauté cooking program is finished, then press **Keep Warm**. Use **+** and **-** to set the keep warm time.

Sautéing before Slow Cooking

Quite often, you'll want to sauté foods to brown them before further cooking them.

1. Sauté ingredients.
2. Press **Cancel**.
*You can deglaze the Cooking Pot now before switching to **Slow Cook** (see **Deglazing** below)*
3. When you're ready, start the process for Slow Cooking.

Deglazing

Deglazing is the process of adding liquid to a hot pan, releasing all of the delicious, caramelised pieces stuck to the bottom.

1. Remove food from Cooking Pot.
2. Add water, broth, or wine.
3. Use wooden spoon or silicone spatula to loosen food stuck to bottom of the Cooking Pot.

KEEP WARM

You can choose to have Keep Warm turn on automatically after cooking on most Smart Programmes. You can also use Keep Warm to reheat foods.

To keep warm

1. When cooking is finished for most programmes, Keep Warm begins.
2. To turn Keep Warm off, press **Cancel**.

To reheat

1. Place the Cooking Pot with the food you want to reheat into the cooker base.
2. Press **Keep Warm** once to set the cooking temperature to Low.
3. Or press **Keep Warm** twice to set the cooking temperature to High.
4. The default Keep Warm time flashes. To select it, press **Start**. Or press **+** or **-** to change it, then press **Start** to select it.
5. To turn Keep Warm off, press **Cancel**.

Programme	Default Time	Min Time	Max Time
Keep Warm	10 hours (10:00)	1 hour (01:00)	10 hours (10:00)

GRAIN COOKING TABLE

20 Cup Multigrain Rice Cooker + Steamer

Grain Type	Cooking Programme	3-4 servings			14-18 servings		
		Grain Amount	Water Amount	Cooking Time	Grain Amount	Water Amount	Cooking Time
White Rice (long grain)	White Rice	1 cup (min)	1 1/2 cups	32 min	7 cups (max)	10 1/2 cups	53 min
Brown Rice	Brown Rice	1 cup (min)	1 1/4 cup	51 min	6 cups (max)	7 1/2 cups	1 hr 6 min
Quinoa	White Rice	1 cup (min)	1 1/2 cups	34 min	6 cups (max)	9 cups	50 min
Barley (pearl barley)	Brown Rice	1 cup (min)	2 cups	58 min	3 cups (max)	6 cups	1 hr 3 min
Bulgur (#3 light bulgur)	Brown Rice	1 cup (min)	1 cup	43 min	6 cups (max)	6 cups	1 hr 2 min
Red Rice	Brown Rice	1 cup (min)	1 1/2 cups	56 min	6 cups (max)	9 cups	1 hr 10 min
Black Rice	Brown Rice	1 cup (min)	1 3/4 cups	57 min	6 cups (max)	10 1/2 cups	1 hr 8 min
Millet	White Rice	1 cup (min)	2 cups	36 min	6 cups (max)	12 cups	49 min
Spelt	Brown Rice	1 cup (min)	1 1/2 cups	1 hr	6 cups (max)	9 cups	1 hr 17 min
Oats (rolled oats)	Steam <i>no steam basket</i>	1 cup (min)	2 cups	12 min	5 cups (max)	10 cups	20-25 min
Mixed grains	Brown Rice	1 cup (min)	1 1/2 cups	49 min	6 cups (max)	9 cups	51 min
Lentil (green) Note: Drain extra water after cooking	Steam <i>no steam basket</i>	1 cup (min)	2 cups	18-20 min	4 cups (max)	8 cups	22-25 min

Note: Measurements use the included Measuring Cup, which is equivalent to 180 ml. Exceeding the maximum amount of grain may lead to overflow.

STEAMING TIMETABLE

You can cook more than just rice in your Instant Rice Cooker + Steamer. Here are some suggested times for common foods.

Food	Prep	Amount (with 1 cup water)	Cook Time
Fresh			
Asparagus	Whole	226 g	10-12 min
Baby White Potatoes	Whole	226 g	20-22 min
Bok Choy	Halves	226 g	13-5 min
Broccoli	Florets	226 g	12-14 min
Cabbage	Quartered, wedges	454 g	25-30 min
Carrots	Individual baby size	226 g	15-17 min
Cauliflower	Florets	226 g	13-15 min
Green Beans	Whole	226 g	10-12 min
Salmon	Filet	2 pc (226 g)	18-20 min
Spinach	Leaves	113 g	5-6 min
Squash	Cubed	226 g	15-17 min
Sweet Potatoes, Potatoes	Diced, medium	226 g	13-15 min
White Button Mushrooms	Whole	226 g	12-14 min
White Fish (cod, haddock, bass)	Filet	2 pc	18-20 min
Courgette	Sliced, 1/2" rounds	226 g	8-10 min
Frozen			
Bao Buns		226 g	13-15 min
Dim Sum		226 g	15-17 min
Steamed Bun (meat or vegetable)		226 g	18-23 min

TROUBLESHOOTING

Problem	Cause	Solution
Difficulty closing lid	Pushing down too hard/ too fast	<ul style="list-style-type: none"> • Close lid slowly.
Difficulty closing lid	Inner lid cover is not installed properly	<ul style="list-style-type: none"> • Open lid and reinstall inner lid cover ensuring the lid cover is located in the positioning slot, is flat against the lid and snapped in place.
Difficulty opening lid	Open button is not completely depressed.	<ul style="list-style-type: none"> • Push firmly on the center of the open button.
Steam leaks from side of lid	Inner lid cover is missing	<ul style="list-style-type: none"> • Install inner lid cover.
Steam leaks from side of lid	Inner lid cover gasket is damaged	<ul style="list-style-type: none"> • Replace inner lid cover.
Steam leaks from side of lid	Lid not closed properly.	<ul style="list-style-type: none"> • Open, then close lid.
Display remains blank after connecting the power cord	Bad power connection or no power.	<ul style="list-style-type: none"> • Inspect power cord for damage. If damage is noticed, do not use the unit.
Display remains blank after connecting the power cord	Bad power connection or no power.	<ul style="list-style-type: none"> • Check home circuit breaker.
Display remains blank after connecting the power cord	No power to the unit	<ul style="list-style-type: none"> • Contact Customer Care.
Occasional clicking or light cracking sound	Bottom of the Cooking Pot is wet.	<ul style="list-style-type: none"> • Wipe exterior surfaces of Cooking Pot. Ensure heating element is dry before inserting Cooking Pot into cooker base.
E1, E2, E3 or E4 Error code appears on display and cooker beeps continuously	There is an issue with the cooker.	<ul style="list-style-type: none"> • Contact Customer Care.

CLEANING

Clean your Instant Rice Cooker + Steamer after each use. Always unplug the unit and let all parts cool to room temperature before cleaning. Before use or storing, make sure all surfaces are dry.

⚠ WARNING

HOT SURFACES

To prevent electric shock or personal injury, unplug before cleaning.

DO NOT immerse power cord, plug or the appliance in water or other liquid, which may result in electric shock or personal injury.

Part	Cleaning instructions
Accessories <ul style="list-style-type: none">• Rice Spoon• Measuring Cup• Inner Lid Cover	<ul style="list-style-type: none">• Wash after each use• Hand wash with hot water and mild dish soap or wash in dishwasher, top rack• Never use harsh chemical detergents, powders or scouring pads on accessories
Cooking Pot CarbReduce Steam Basket	<ul style="list-style-type: none">• Wash after each use.• Hand wash with hot water and mild dish soap or wash in dishwasher.• Hard water stains may need a vinegar-dampened sponge and scrubbing to remove• For tough or burned food residue, soak in hot water for a few hours before cleaning• Dry all exterior surfaces before placing in cooker base
Power cord	<ul style="list-style-type: none">• Use a barely-damp cloth to wipe any particles off cord
Cooker base with lid	<ul style="list-style-type: none">• Wipe the inside of the cooker base as well as the condensation rim with a barely-damp cloth, and allow to air dry• Clean the lid, outside of the cooker base and the control panel with a soft, barely-damp cloth or sponge

LEARN MORE

There's a whole world of Instant Rice Cooker + Steamer information and help just waiting for you. Here are some of the most helpful resources.

Register your product

instantpot.co.uk/product-registration

Contact Customer Care

instantpot.co.uk/support

UKSupport@instantpot.com

EUSupport@instantpot.com

Instant Brands® Connect App with 100s of recipes

iOS and Android app stores

Cooking charts and more recipes

instantpot.co.uk/recipes

Replacement parts and accessories

instantpot.co.uk/product-category/instant

Join the community



Product specifications

Model	Volume	Wattage	Power
MRRRC2001WE	20 Cups 2.8 Litres	860 W	220-240 V ~ 50-60 Hz

WARRANTY

Instant Brands (EMEA) Limited, Instant Brands (Ireland) Limited, and Instant Pot Brands (collectively the "Company") warrant this appliance to be free from defects in workmanship and material, under normal household use, for a period of one (1) year from the date of original purchase. This Limited Warranty extends only to the original purchaser and use of the appliance in the UK and EU and must be purchased by an authorised distributor of Instant Brands. This warranty does not cover appliance use outside of the UK and EU.

Proof of original purchase date and, if requested, return of your appliance is required to obtain service under this Limited Warranty. Provided that this appliance is operated and maintained in accordance with the written instructions included with the appliance (which are also available at instantpot.co.uk), the Company will, at its sole discretion, either: (i) repair defects in materials and workmanship; or (ii) replace the appliance. In the event the appliance is replaced, the Limited Warranty on the replacement appliance will expire 12 months from the date of original consumer purchase (UK only).

The Company is not responsible for shipping costs for warranty service.

Limitation and Exclusions

Any modification or attempted modification to your appliance may interfere with the safe operation of the appliance and may result in serious injury and damage. Any modification or attempted modification to your appliance or any part thereof will void the warranty, unless such modification(s) or alteration(s) were expressly authorised by the Company.

This warranty does not cover (1) normal wear and tear; (2) damage resulting from negligent, unreasonable or misuse of the appliance, improper assembly or disassembly, use contrary to the operating instructions, failure to provide reasonable and necessary maintenance, Acts of God (such as fire, flood, hurricanes and tornadoes), or repair or alteration by anyone, unless expressly directed and authorised by the Company; and (3) repairs where your appliance is used for other than normal household use and in a manner contrary to published user or operator instructions.

To the extent permitted by applicable law, the liability of the Company, if any, for any allegedly defective appliance or part shall be limited to repair or replacement of the appliance or part thereof, and shall not exceed the purchase price of a comparable replacement appliance. Except as expressly provided herein and to the extent permitted by law, (1) the Company makes no warranties, conditions or representations, express or implied, usage, custom of trade or otherwise with respect to the appliance or parts covered by this warranty and (2) the Company shall not be responsible or liable for indirect, incidental or consequential damages arising out of or in connection with the use or performance of the appliance or damages with respect to any economic loss, loss of property, loss of revenues or profits, loss of enjoyment or use, costs of removal, installation or other consequential damages of any nature or kind.

You may have rights and remedies under applicable laws, which are in addition to any right or remedy which may be available under this limited warranty.

WARRANTY

Please visit instantpot.co.uk/product-registration/ to register your appliance. You will be asked to provide your name, your email address, the store name, date of purchase, model number and serial number (both of which are found on the appliance). This registration will enable us to keep you up-to-date with product developments and recipes, and contact you in the unlikely event of a product safety notification. By registering, you acknowledge that you have read and understood the instructions for use and warnings accompanying the appliance.

Warranty Service

To obtain warranty service, please contact our Customer Care Department by creating a support ticket online at instantpot.co.uk/support/. If we are unable to resolve the problem, you may be asked to send your appliance to the Service Department for quality inspection. Instant Brands is not responsible for shipping costs related to warranty service. When returning your appliance, please include your name, mailing address, email address, phone number, and proof of the original purchase date as well as a description of the problem you are encountering with the appliance.

Within the UK

Instant Brands (EMEA) Limited,
Floor 6, Block C, Dukes Court,
Duke Court, Woking, GU21 5BH, UK

Email: UKSupport@instantpot.com

Telephone: +44 (0) 3331 230051

This warranty was last updated on 1 September 2019 for all products sold from [1 November 2019]. If your product comes with our older warranty version, your warranty will continue to be honoured.

Recycling

This appliance complies with the WEEE Directive 2012/19/EU on the disposal of electrical and electronic equipment (WEEE). This appliance complies with the European directive for electromagnetic compatibility (EMC) 2014/30/EU and its revisions, as well as Low Voltage Directive (LVD) 2014/35/EU and its revisions. This marking indicates that this product should not be disposed of with other household waste throughout the UK and EU. To prevent possible harm to the environment or human health from uncontrolled waste disposal, recycle it responsibly to promote the sustainable re-use of material sources. To return your used device, please use the return and collection systems or contact Customer Care for further recycling and WEEE information.



CarbReduce™ STUDY

How it works

- CarbReduce is a two-step function that allows carbs and sugars to separate from the rice during the cooking process.
- The rice is both boiled and steamed, with the steaming being done later in the cooking process.
- This process works by placing the rice in the CarbReduce basket and adding extra water for cooking.
- As the rice absorbs the water, the boiling process turns to a steam process, separating and draining sugars and starches into the pot below.
- When the cooking process is complete, fluffy, delicious rice is left in the basket and starch and sugars are isolated in the bottom of the cooker.

The results

- Reduction of carbohydrates and sugar by up to 40%.

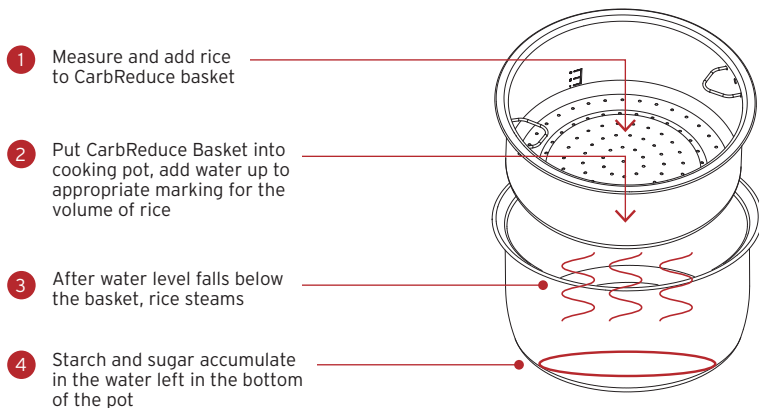

How we tested it

Objective

To test for the reduction of digestible starch in rice varieties when using the CarbReduce™ function.

Samples

The following commonly available, national brands of rice were tested.

Long Grain White/Riceland | Long Grain White/Verde Valle |
Long Grain Brown/Iberia | Short Grain White/Rice Select |
Basmati White/Mahatma | Arborio White/Rice Select

A total of 4 multi-grain cookers were used in the testing.

- Quantity = 2, 12 Cup machines
- Quantity = 2, 20 Cup machines

Laboratory

Testing was conducted by:

Eurofins S-F Analytical Laboratories

2345 S. 170th St.

New Berlin, WI 53151

Procedure

Samples of rice were cooked by the traditional method using the White Rice and Brown Rice functions and compared to samples of rice cooked in the CarbReduce basket using the CarbReduce function. All tests use tap water unless otherwise specified.

Cooked rice samples are analysed for their resistant starch by “Official Methods of Analysis of AOAC International (2005), 18th Ed., AOAC International, Gaithersburg, Maryland, USA, Official Method 2002.02” and digestible starch by “Official Methods of Analysis of AOAC International (2005), 18th ED, AOAC International, Gaithersburg, MD, USA, Official Method 996.11 (mod.)”

Results in percent reduction of digestible starches are provided.

Conclusion

Using the CarbReduce cooking method can reduce the carbs in cooked rice by up to 40%.

Instant Brands (EMEA) Limited

Floor 6, Block C, Dukes Court,
Duke Court, Woking, GU21 5BH, UK

Instant Brands (Ireland) Limited

Suite 6, Rineanna House, Shannon
Free Zone, Shannon, Co Clare,
Ireland, V14 CA36

instantpot.co.uk

© 2025 Instant Pot Brands

INSTANT and INSTANT POT
BRANDS are registered trademarks
of Instant Pot Brands